

modello

# COMPACT 12

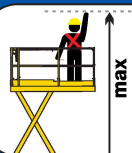

## VERTICALI

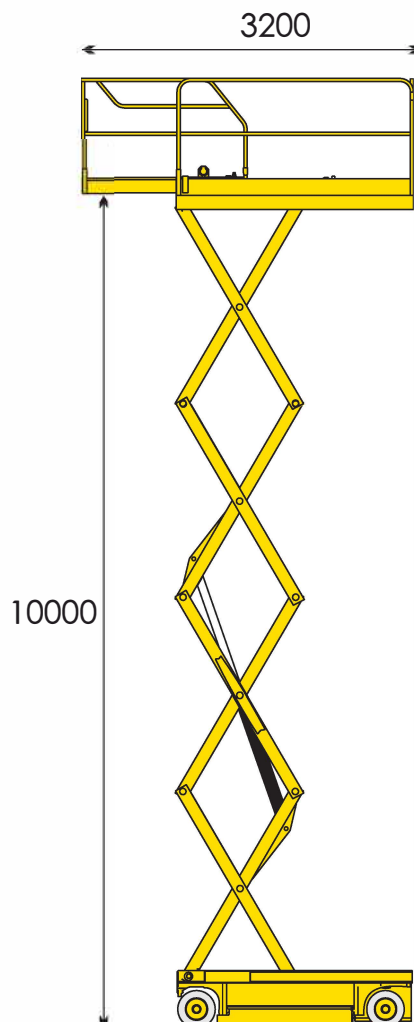
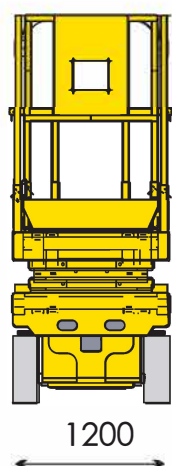
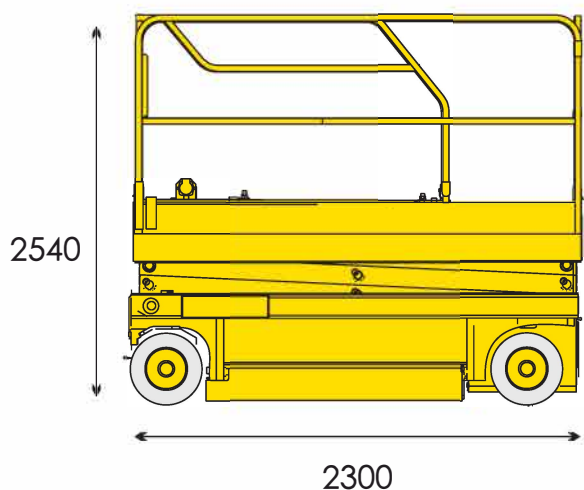

12,00



300 KG

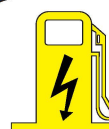

ELETTRICA



3,20

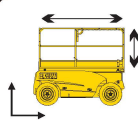

2,30x1,20 m



23%



10,00

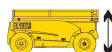

1,26

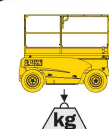

2630 KG

## VERTICALI ELETTRICI